

PERMEABLE PAVING UNIT

Permeable 3 1/4" x 18" x 4"

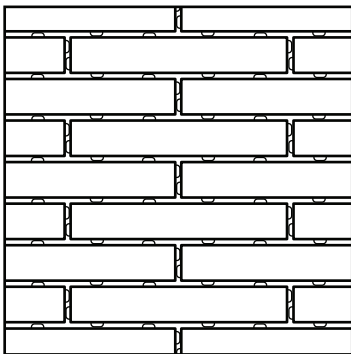

Running Bond

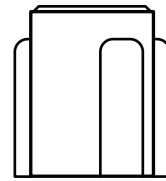
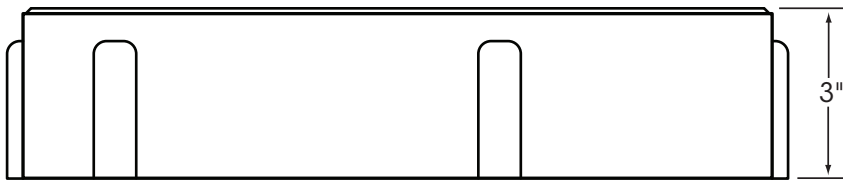
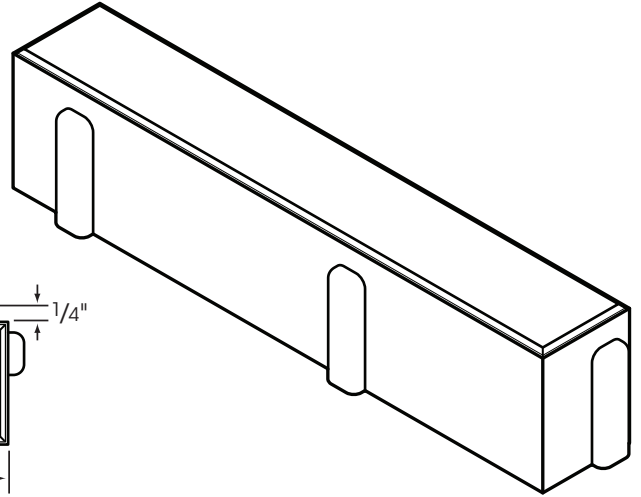
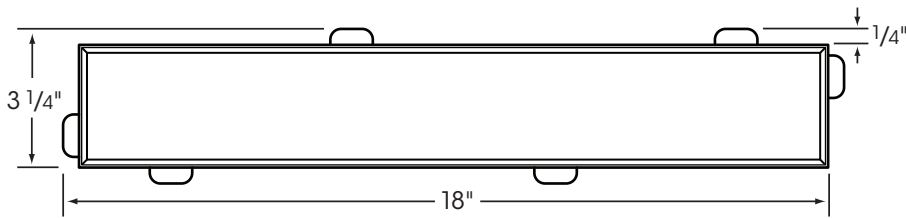
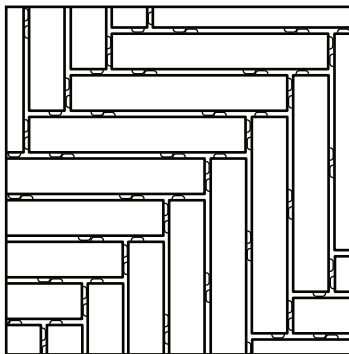

90° Herringbone

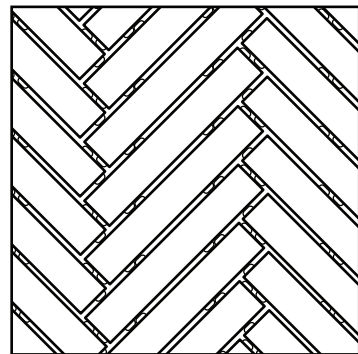

45° Herringbone

Please Note: Sizes shown are nominal. Products are made to fit metric modules.
Overall dimensions include one spacer.

HANOVER®

Architectural Products

5000 Hanover Road, Hanover, PA 17331

717.637.0500 fax 717.637.7145

www.hanoverpavers.com