

NEW 3D Diamond™ Asphalt Block

Hanover's NEW 3D Diamond™ Asphalt Block can create amazing three dimensional paving designs. The shape can be installed alone or with a nominal 8 x 8" square. As these pieces are turned and alternated using shape and color, a three dimensional effect emerges. The design effects are almost limitless. Designs can be subtle or striking depending on the shape combinations and colors selected.



Asphalt Block is manufactured with colorful aggregates to produce an attractive paver. Hanover[®] manufactures several finished and a wide range of colors with custom blending available on special order when quantities permit. However, the finish of the asphalt block can affect the appearance of the color. Asphalt Block are available in three finishes, each allowing the aggregates used to

be seen in a different way. Please contact a Hanover[®] representative for more information.

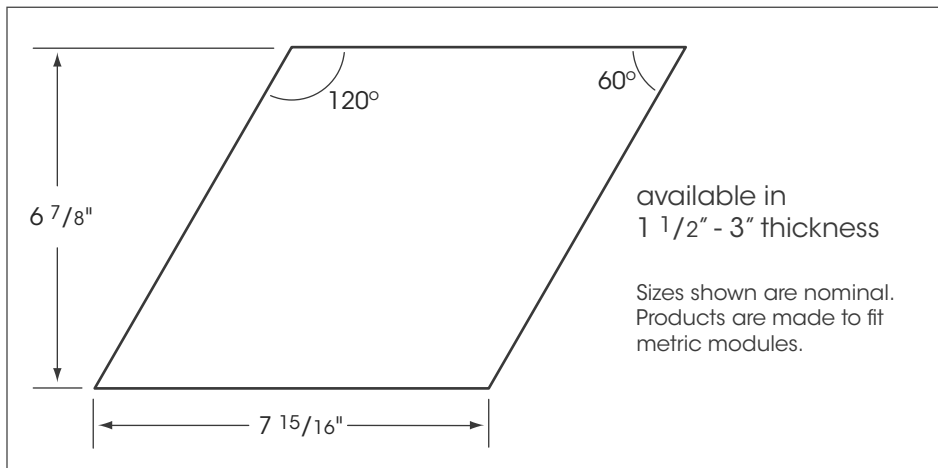

Create amazing
three dimensional
effects!



3D Diamond Installation Designs

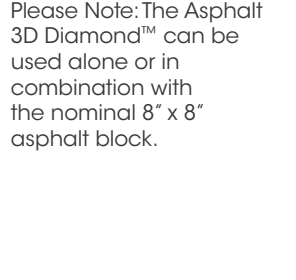
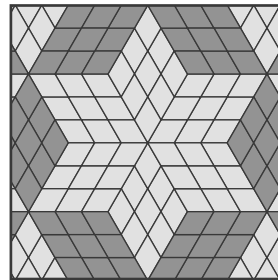
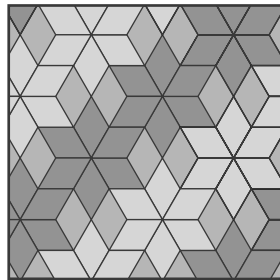
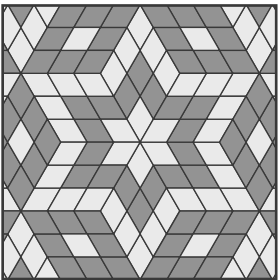
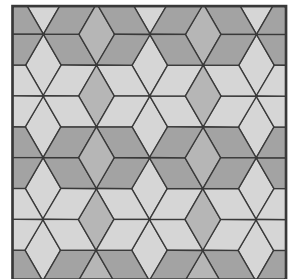
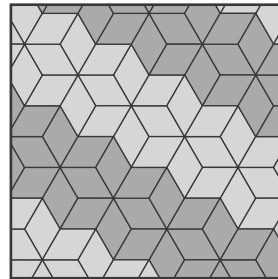
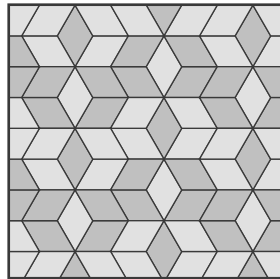
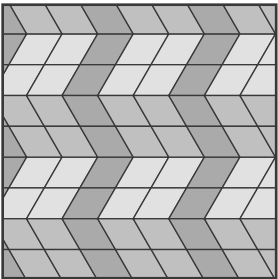
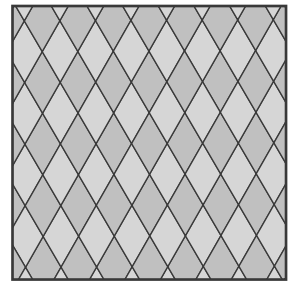
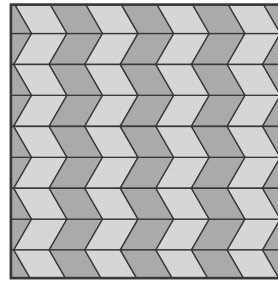
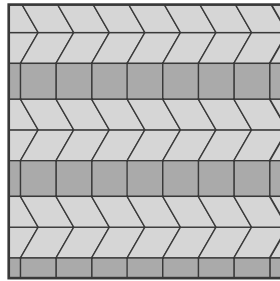
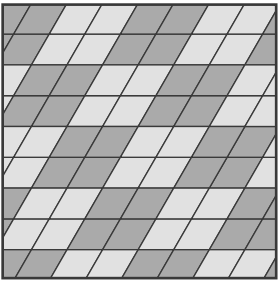
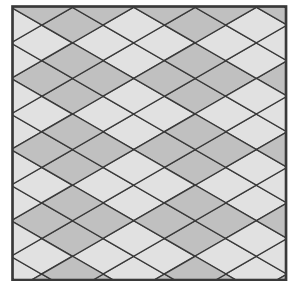
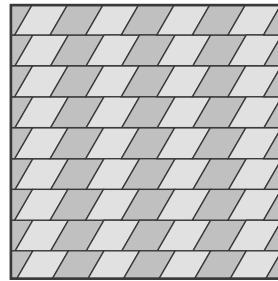
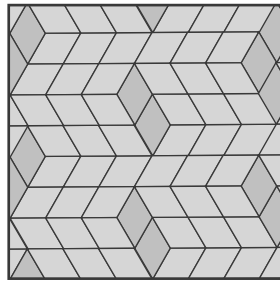
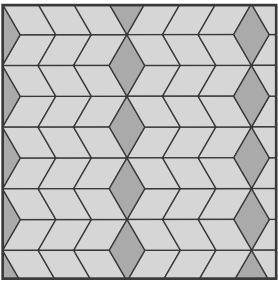
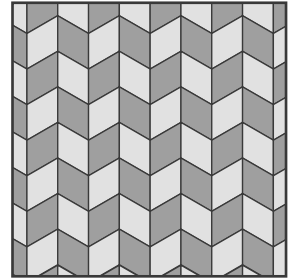
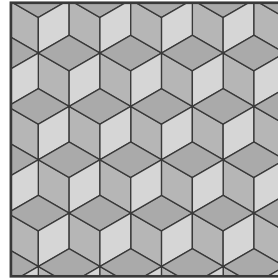
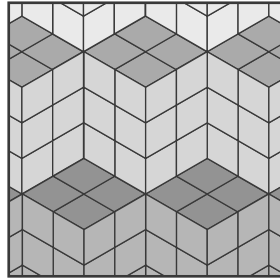
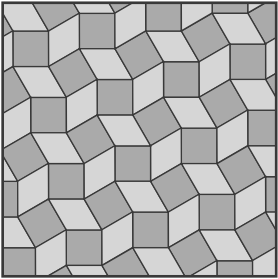

Please Note: The Asphalt 3D Diamond™ can be used alone or in combination with the nominal 8" x 8" asphalt block.



Where Concrete and Imagination Meet

240 Bender Road, Hanover, PA 17331
voice 717.637.0500 fax 717.637.7145
www.hanoverpavers.com